

SU-XL SERIES SQUARE DRIVE WRENCH



A time-tested and proven tool design, square drive ratchets offer a cost-efficient option to handle a wide range of bolting make-up and break-out needs.

The SU-XL Series ratchet is a patented design, which increases accuracy and reduces the number of moving parts.

Our standard SU-XL Series tool capacities range from 100 to 60,000 foot pounds of torque using a 10,000 p.s.i. hydraulic pump.

SQUARE DRIVE

Sizes from $\frac{3}{4}$ " to $2\frac{1}{2}$ " work with all standard-size impact sockets. The square drive shifts from make-up to break-out seamlessly, without having to disassemble the tool.

UNIBODY

Eliminates "Pinch Points" and reduces side loading. The completely-enclosed drive train assembly allows nothing in or out of the tool, during operation.

REACTION MEMBER

All SU-XL series models of 11,000 ft./lbs. or lower are armed with a 360° reversable reaction member that has 48 splines. That gives operators 96 different positions to choose from when looking for proper reaction, increasing safety, and decreasing headaches.

PISTON ROD

The slotted piston rod always maintains a 90° relationship between itself and the nut. This significantly increases accuracy of the tool while simultaneously reducing the number of moving parts it has inside it.

PAWL RELEASE

The anti-reverse pawl inside the tool holds rotational wind-up in order to maintain required torque. The anti-reverse pawl mechanism on either side of the tool body allows manual release of the tool if "binding" occurs.

PATENTED 360° SWIVELS

Allow hose movement without hose binding. Nickel-plated steel quick connects, with fewer moving parts, moving in every direction you might need them to – a great improvement to other swivels in the industry.

CALIBRATED

Every tool is tested and calibrated to +/- 0.03 accuracy and +/- 0.01 repeatability traceable to N.I.S.T. standards.

SU-XL SERIES

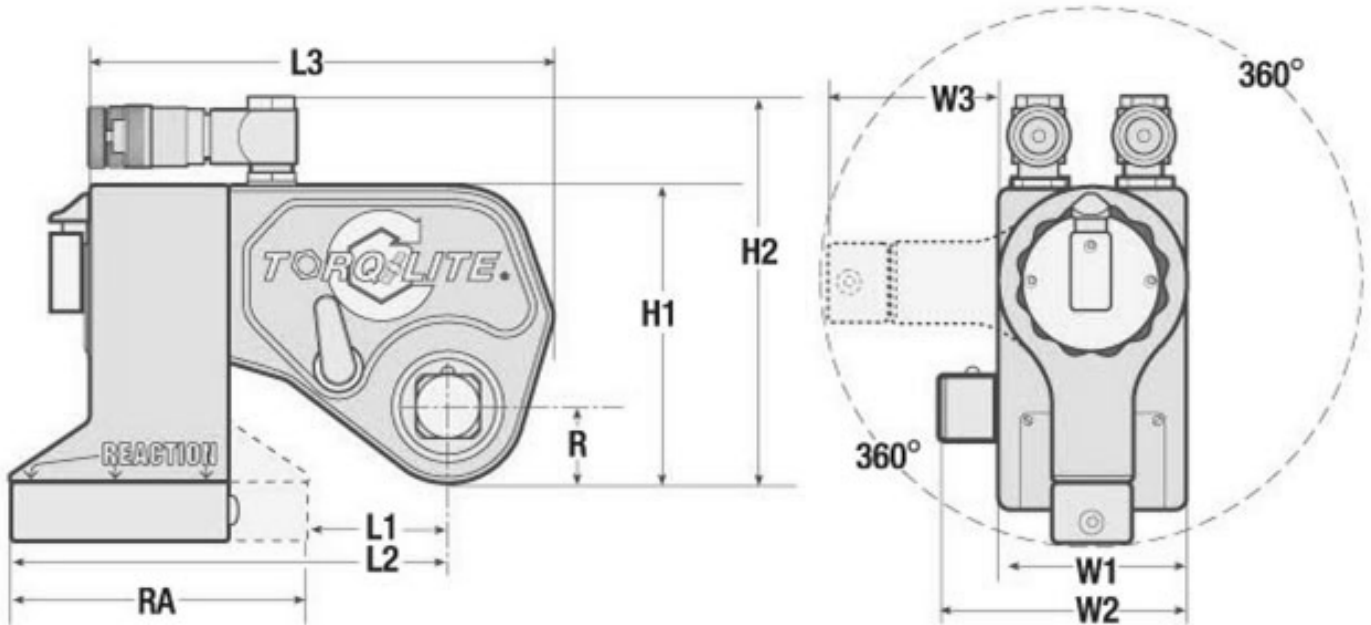

SU-XL SERIES	SQUARE DRIVE		MIN/MAX FT./LBS. @10,000 PSI	MIN/MAX NM @700 BAR	WEIGHT
SU-1XL	3/4"	19mm	143/1,382	194/1,874	7 lbs.
SU-3XL	1"	25mm	262/2,921	355/3,960	14 lbs.
SU-6XL	1 1/2"	38mm	564/5,110	765/6,928	21 lbs.
SU-8XL	1 1/2"	38mm	848/8,545	1,150/11,585	31 lbs.
SU-11XL	1 1/2"	38mm	1,038/10,793	1,407/14,633	36 lbs.
SU-20XL	2 1/2"	64mm	1,753/17,934	2,377/24,315	75 lbs.
SU-30XL	2 1/2"	64mm	2,638/25,804	3,577/34,986	91 lbs.
SU-45XL	2 1/2"	64mm	4,400/46,631	5,966/63,223	150 lbs.
SU-60XL	2 1/2"	64mm	5,113/54,905	6,932/74,441	296 lbs.

*Weight includes reaction member and square drive.

SU-XL SERIES	REACTION AREA	L1	L2	RADIUS	H1	H2	W1	W2	W3
SU-1XL	3.685"	1.567"	5.252"	1.200"	4.100"	5.725"	1.980"	2.730"	2.200"
SU-3XL	5.335"	1.865"	7.200"	1.260"	4.990"	6.615"	2.775"	3.600"	3.172"
SU-6XL	5.460"	2.150"	7.610"	1.725"	6.180"	7.800"	3.140"	4.475"	3.501"
SU-8XL	6.500"	2.040"	6.880"	1.800"	6.770"	8.420"	3.900"	5.350"	4.800"
SU-11XL	6.500"	2.245"	8.745"	2.062"	7.664"	9.290"	3.900"	5.350"	4.982"
SU-20XL	7.525"	3.460"	10.375"	3.000"	9.490"	11.115"	4.950"	7.450"	5.557"
SU-30XL	7.525"	3.460"	10.875"	3.125"	10.375"	12.000"	5.875"	8.375"	5.555"
SU-45XL	7.425"	7.337"	12.537"	3.275"	11.225"	12.600"	5.750"	8.250"	5.500"
SU-60XL	8.781"	5.887"	14.668"	3.750"	14.000"	15.600"	7.250"	9.750"	5.750"